**CD****WŁAŚCIWOŚCI / FEATURES**

Elektryczne pompy odśrodkowe z pojedynczym wirnikiem. Stosowane w domowych i przemysłowych instalacjach wspierających wzrost roślin, do małego i średniego nawadniania.

Single impeller centrifugal electric pumps. Used for domestic and industrial booster plants, small and medium irrigation.

MATERIAŁY / MATERIALS

- Korpus pompy: żeliwo szare
- Uchwyt silnika: żeliwo szare
- Wał ze stali nierdzewnej AISI 416 (Hp0,8-Hp1), AISI 303 (Hp1,5-Hp2,2-Hp3-Hp4-Hp5,5)
- Wirnik z Noryl® dla modeli CD66, CD67, CD68P, CD69P, CD70P, wirnik z mosiądzu dostępny na życzenie
- Wirnik z mosiądzu dla modeli CD71, CD72
- Uszczelnienie mechaniczne: ceramiczno grafitowe

- *Cast-iron pump body*
- *Cast-iron motor bracket*
- *Stainless steel shaft AISI 416 (Hp0,8-Hp1), AISI 303 (Hp1,5-Hp2,2-Hp3-Hp4-Hp5,5)*
- *Impeller of Noryl® for mod. CD66, CD67, CD68P, CD69P, CD70P, brass impeller available on request*
- *Impeller of brass for mod. CD71, CD72*
- *Ceramic graphite mechanical seal*

SILNIK / MOTOR

- Silnik zamknięty samo-wentylujący
- Stopień ochrony: IP44
- Klasa izolacji F
- Zasilanie jednofazowe 230 V-50 Hz z zabezpieczeniem termicznym
- Zasilanie trójfazowe 230/400V-50Hz

- *Motor: closed self-ventilated*
- *Protection: IP44*
- *Insulation class F*
- *Single-phase feeding 230V-50Hz, with motor protection*
- *Three-phase feeding 230/400V-50Hz*

WARUNKI DZIAŁANIA / OPERATING CONDITIONS

- Maksymalne ciśnienie 8 bar (6 bar dla pomp CD66 oraz CD67)
- Maksymalna temperatura wody: 50°C przy wirnikach z Norylu®
- Maksymalna temperatura wody: 90°C przy wirnikach z mosiądzu

- *Max. pressure 8 bar (6 bar for CD66, CD67)*
- *Max. water temperature: 50°C for Noryl® impeller*
- *Max. water temperature: 90°C for brass impeller*



ELEKTRYCZNA, JEDNOWIRNIKOWA POMPA ODŚRODKOWA
SINGLE-IMPELLER CENTRIFUGAL ELECTRIC PUMPS

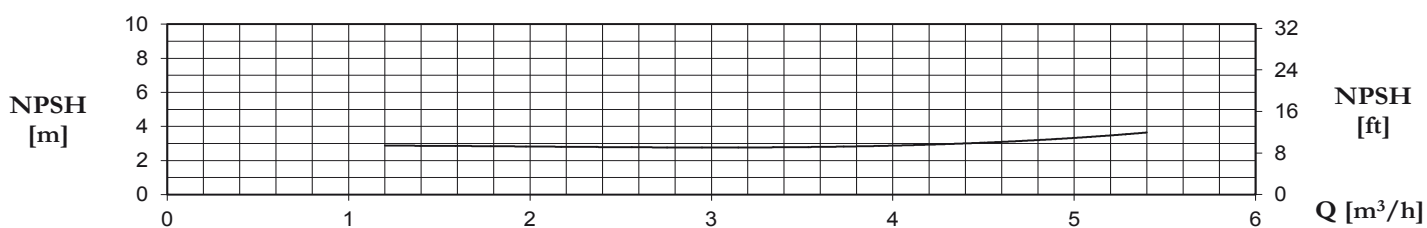
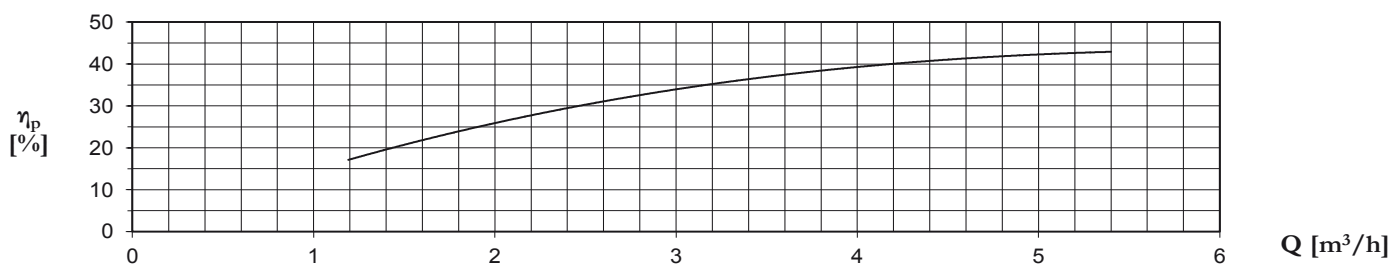
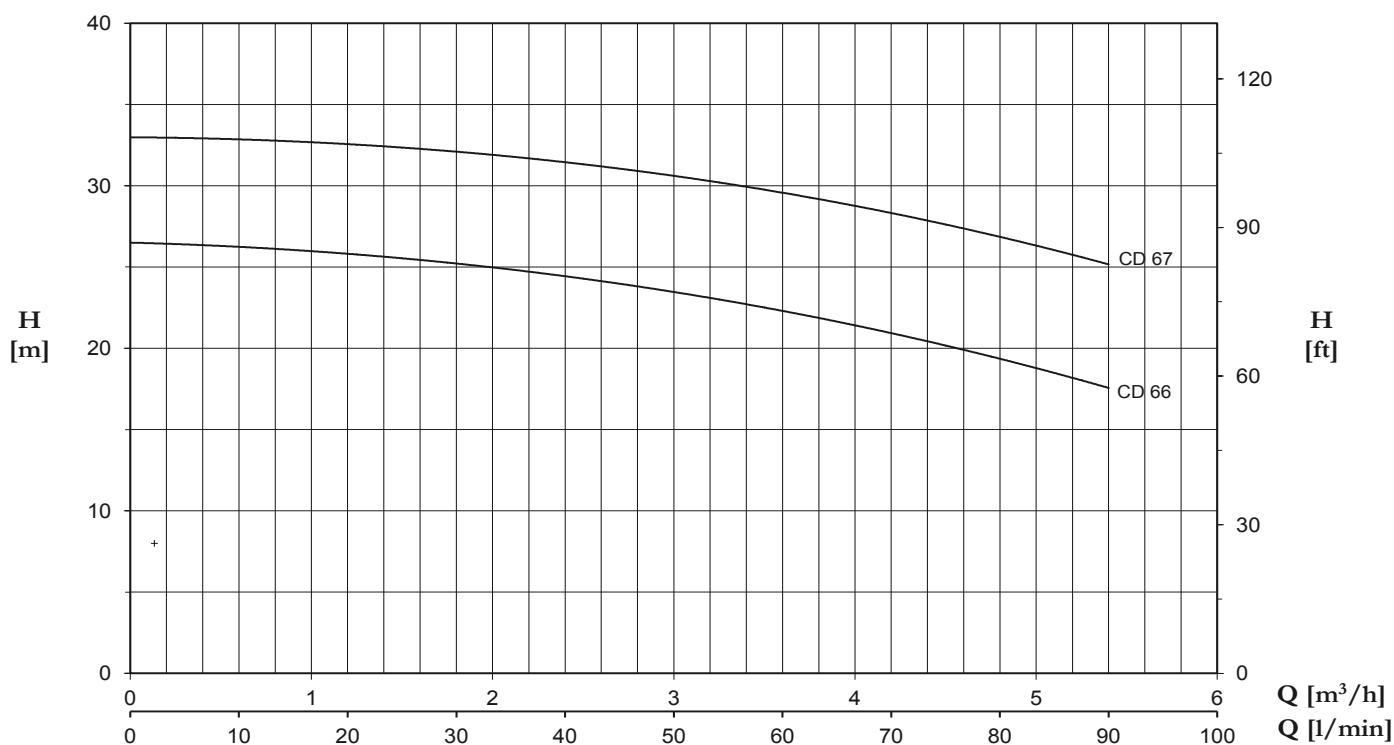

DANE TECHNICZNE PRZY 2900 OBR./MIN. / TECHNICAL PERFORMANCE AT 2900 RPM

Model <i>Model</i>		P2		A		Q=Wydajność - Capacity																		
1~	3~	HP	kW	1x230V	3x400V	m³/h0	1,2	2,4	3	3,6	4,8	5,4	6	6,6	7,2	7,8	9	12	15	18	21			
						l/min0	20	40	50	60	80	90	100	110	120	130	150	200	250	300	350			
Całkowita wysokość podnoszenia w m słupa wody <i>Total head in meters w.c.</i>																								
CD 66	CD 66T	0,8	0,59	4,5	1,7	26,5	25,8	24,5	23	22,2	19,5	17,5												
CD 67	CD 67T	1	0,74	5,7	2	33	32,5	31,5	30	29,6	26,8	25,2												
CD 68P14	CD 68P14T	1,5	1,1	8,5	3,4	40,5	39,3	38,6	28	37,5	35,6	34,6	32,5	29,5										
CD 69P14		2	1,5	10,3		45,1	44,1	43,3	43	42,3	40,5	39,2	38	36,4	33,5									
	CD 69P14T	2	1,5		4,9	50	48,7	47,8	47	46,5	44,9	43,7	42,5	41,3	39,4									
CD 70P14	CD 70P14T	3	2,2	13,5	5,1	55,9	54,5	53,4	53	52	50,1	48,9	48	46,2	44,2	41,9								
CD 71		4	3	17,8		45,3	45,3	45,3	45,2	45,1	44,9	44,8	44,7	44,5	44	43,5	42,9	40,1	36,6	32				
	CD 71T	4	3		6,6	47	47	47	47	46,9	46,6	46,4	46,2	46	45,8	45,5	44,8	42,5	39,1	35,2				
	CD 72T	5,5	4		9,4	56,5	56,5	56,5	56,5	56,5	56,5	56,5	56,5	56,4	56,3	56,2	56	54,5	51,8	47,9	42,5			

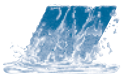

CD

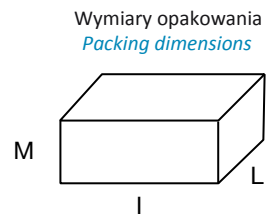
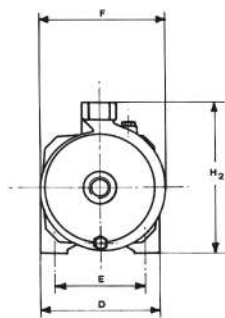
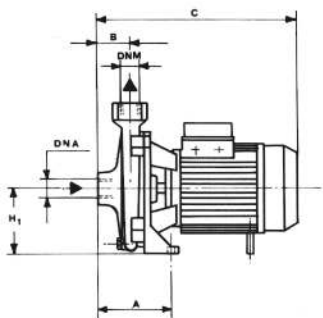
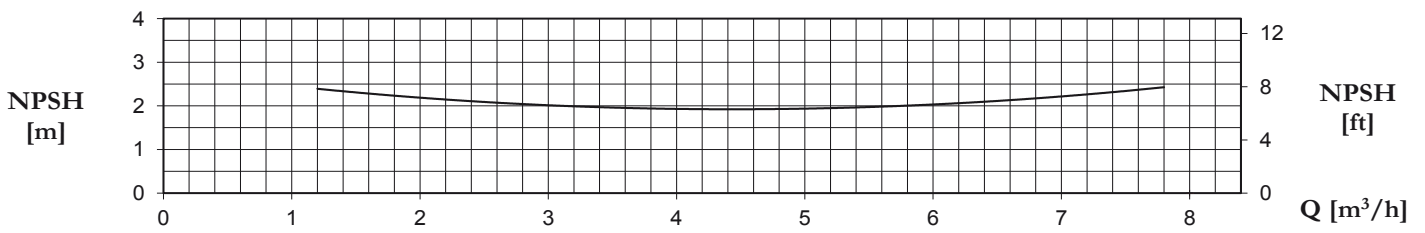
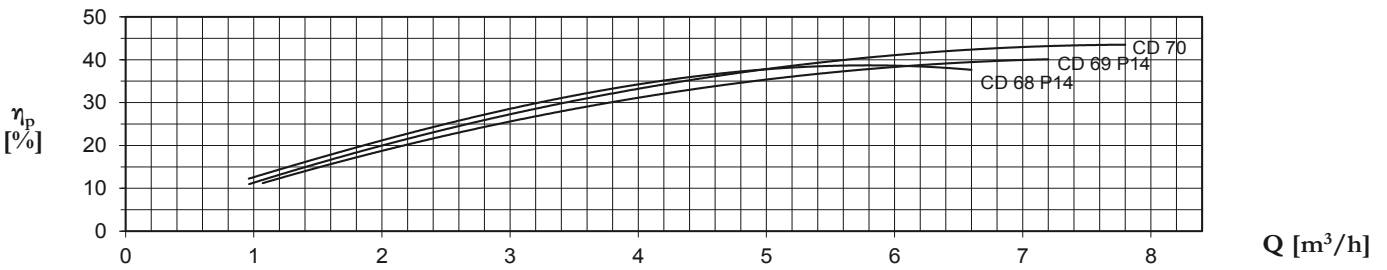
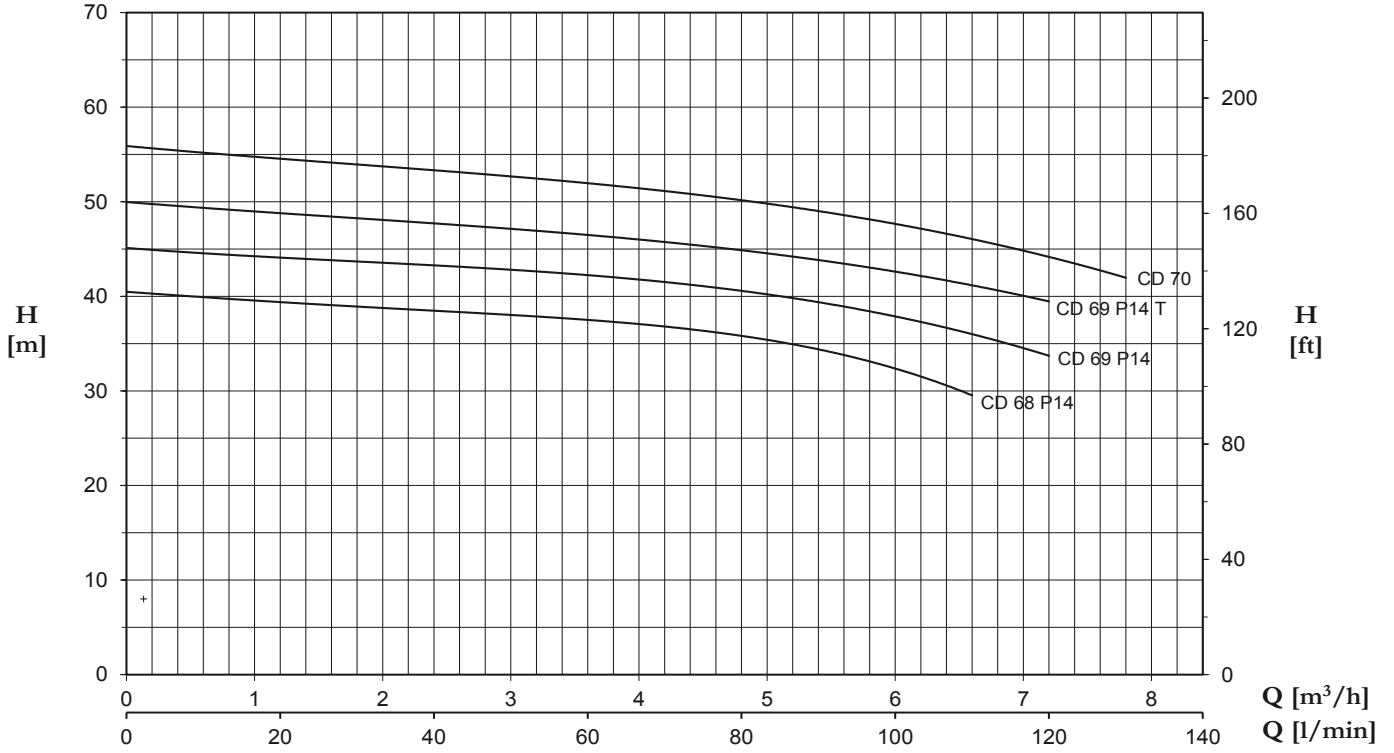

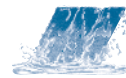

ELEKTRYCZNA, JEDNOWIRNIKOWA POMPA ODŚRODKOWA
 SINGLE-IMPELLER CENTRIFUGAL ELECTRIC PUMPS

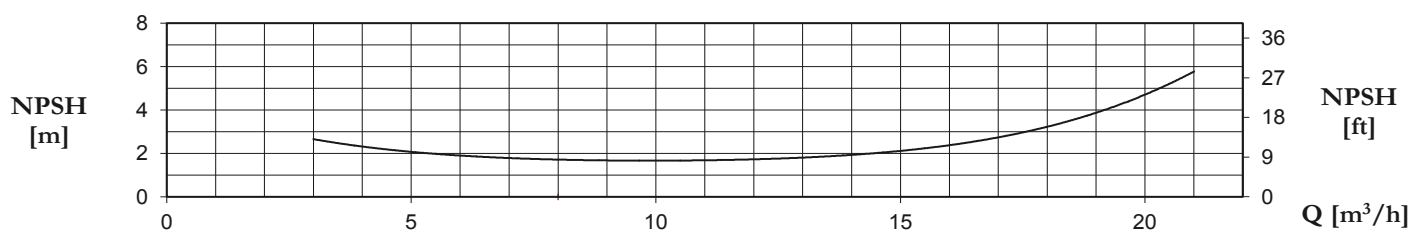
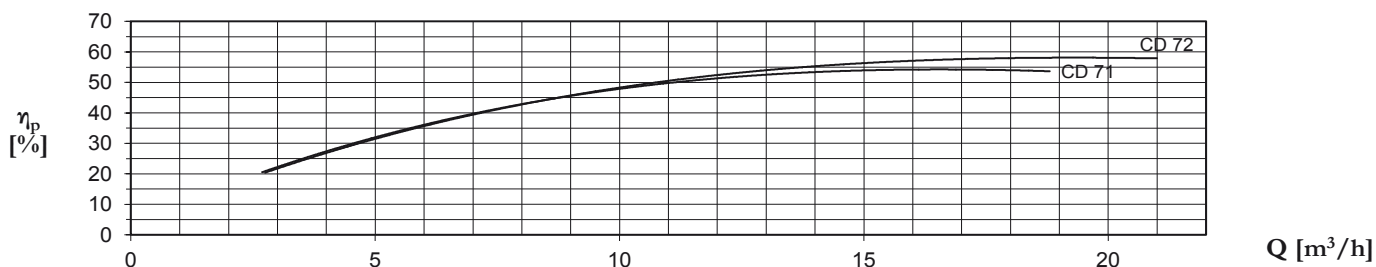
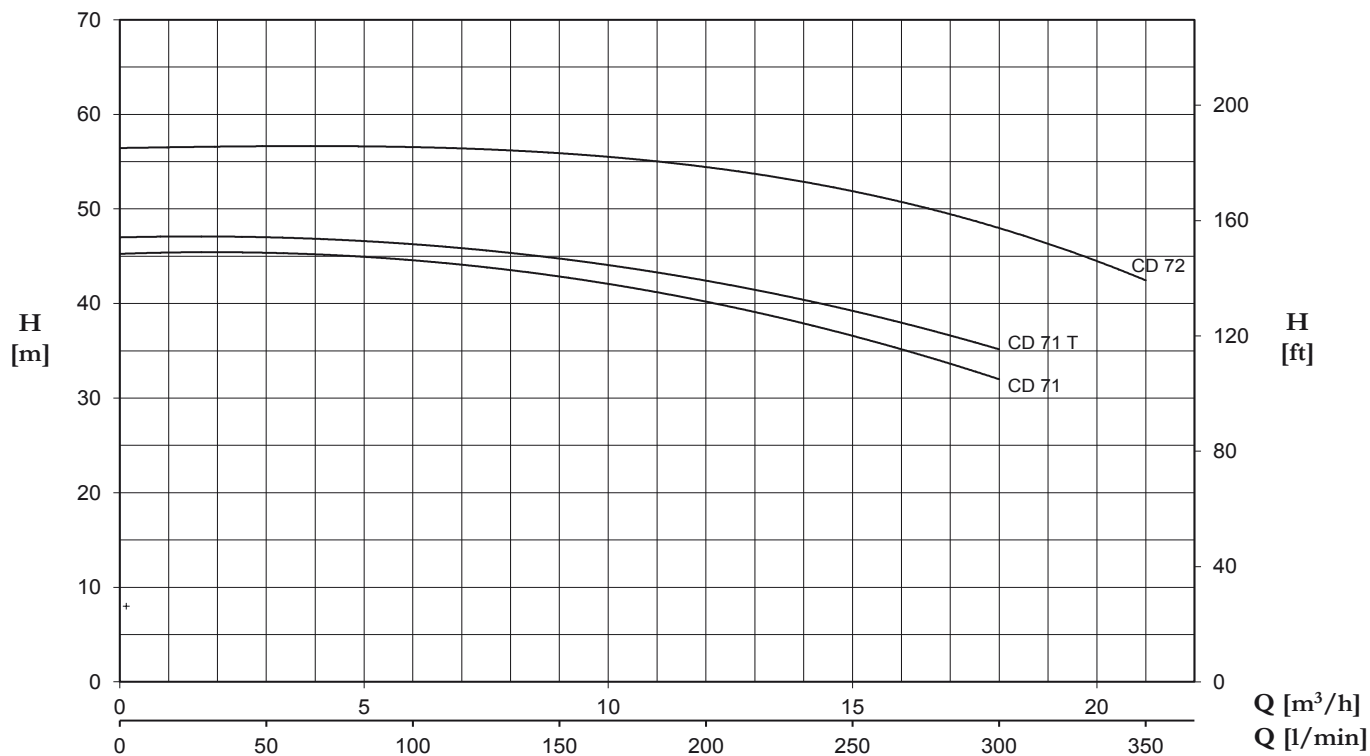

MODEL POMPY PUMP'S MODEL	WYMIARY POMPY mm PUMP'S DIMENSIONS mm										WYMIARY OPAKOWANIA mm PACKING DIMENSIONS mm			WAGA WEIGHT
	A	B	C	D	E	F	H1	H2	DNA	DNM	I	L	M	kg
CD 66	110	46,5	300	180	140	185	97	234	1" G	1" G	325	200	265	12,7
CD 67	110	46,5	300	180	140	185	97	234	1" G	1" G	325	200	265	14
CD 68P14	117	46,5	348	220	180	225	115	285	1" 1/4 G	1" G	370	240	315	22,5
CD 69P14	117	46,5	348	220	180	225	115	285	1" 1/4 G	1" G	370	240	315	23
CD 70P14	117	46,5	348	220	180	225	115	285	1" 1/4 G	1" G	370	240	315	23,5
CD 71	108	54	425	240	190	250	133	323	2" G	1" 1/4 G	440	270	360	39,8
CD 72T	108	54	425	240	190	250	133	323	2" G	1" 1/4 G	440	270	360	39,8