

ULTRA



WŁAŚCIWOŚCI / FEATURES

Wielostopniowe pompy poziome ze stali nierdzewnej. Przeznaczone do pompowania czystych płynów nie zawierających zawiesiny wykorzystywane w aplikacjach domowych oraz w rolnictwie, przemyśle, w systemach zwiększających ciśnienie, nawadnianiu, pompowaniu wody pitnej i glikolu; uzdatnianie wody; przemysł spożywczy; ogrzewanie i klimatyzacja; myjnie samochodowe i systemy myjące.

Stainless steel multistage horizontal pumps. Pumping of clean non-loaded fluids in the domestic, agricultural and industrial sectors; pressurizing systems; irrigation; drinking and glycol water; water treatment; food industry; heating and air conditioning; washing system.

MATERIAŁY / MATERIALS

- Korpus pompy: stal chromo-niklowa AISI 304
- Wirnik, dyfuzor wykonany z Noryl®
- Wał silnika: stal nierdzewna AISI 303
- Uchwyt silnika: aluminium
- Uszczelnienie mechaniczne: ceramiczno-grafitowe do pomp 6 stopniowych - grafit na węgiel krzemowy od pomp 7 stopniowych

- *Pump body: chromo-nickel steel AISI 304*
- *Impellers, diffusers: Noryl®*
- *Motor shaft: AISI 303 stainless steel*
- *Motor bracket: aluminium*
- *Mechanical seal: ceramic-graphite up to 6 stages - graphite-silicon carbide from 7 stages*

SILNIK / MOTOR

- Dwu biegunowy silnik indukcyjny
- Jednofazowy 230V - 50Hz z ochroną termiczną do pomp o mocy do 1,85 kW
- Trójfazowy 230/400 V – 50 Hz
- Klasa izolacji class F
- Stopień ochrony: IP44
- *2 Pole induction Motor*
- *Single Phase 230V - 50Hz with thermal protector up to 1,85 kW*
- *Three Phase 230-400V - 50 Hz*
- *Insulation class F*
- *Protection degree IP 44*

WARUNKI DZIAŁANIA / OPERATING CONDITIONS

- Maksymalne ciśnienie robocze: 10 bar
- Maksymalna temperatura pompowanej cieczy: od - 5 do 35°C
- *Maximum working pressure: 8,5 bar*
- *Maximum liquid temperature: from -5 up to 35 °C*

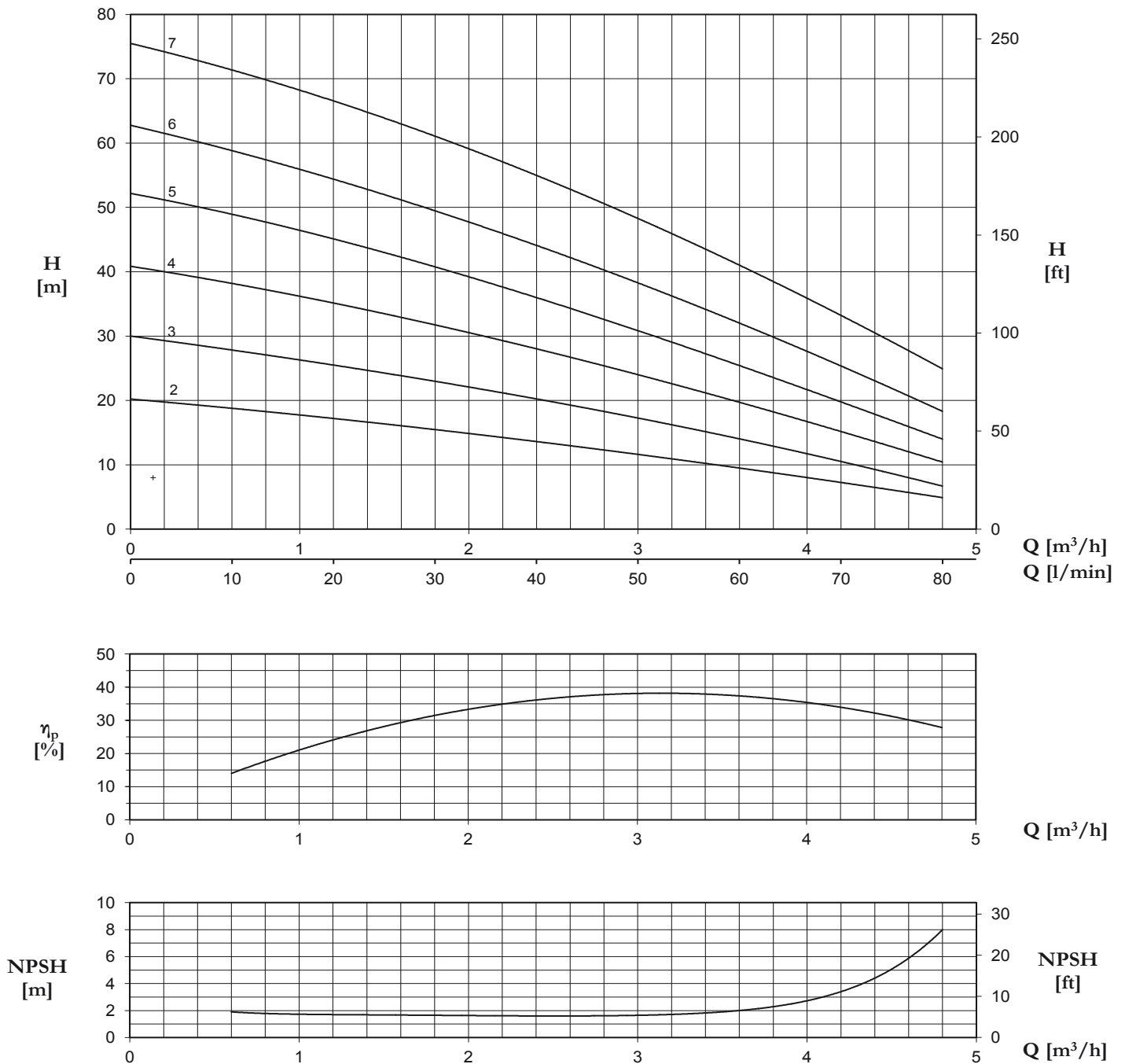

DANE TECHNICZNE PRZY 2900 OBR./MIN. / TECHNICAL PERFORMANCE AT 2900 RPM

Model <i>Model</i>		P2		A		Q (m³/h -l/min)						
1~	3~	HP	kW	1x230V 50Hz	3x400V 50Hz	0	0,6	1,2	1,8	2,4	3,6	4,8
						0	10	20	30	40	60	80
H (m)												
U 3-50/2	U 3-50/2T	0,5	0,37	2	0,9	20,2	18,8	17,3	15,3	13,7	9,5	4,9
U 3-70/3	U 3-70/3T	0,7	0,51	2,9	1,2	30	27,9	25,4	23	20,3	14	6,7
U 3-90/4	U 3-90/4T	0,9	0,66	4	1,8	40,8	38,3	35,1	31,8	27,9	19,8	10,4
U 3-100/5	U 3-100/5T	1	0,75	4,8	1,9	52,2	48,9	45,1	40,8	36	25,4	14
U 3-120/6	U 3-120/6T	1,2	0,9	5,6	2,6	62,8	58,7	54,5	49,6	43,9	32,1	18,3
U 3-150/7	U 3-150/7T	1,5	1,1	7,1	2,9	75,5	71,3	66,6	61,2	54,8	41,1	24,9

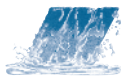

ULTRA

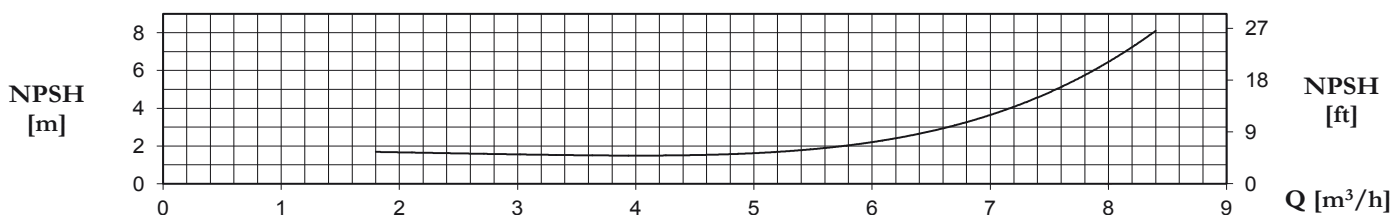
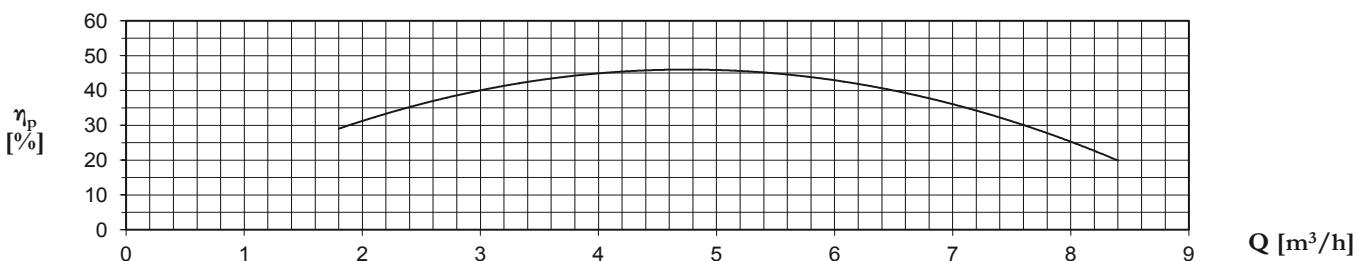
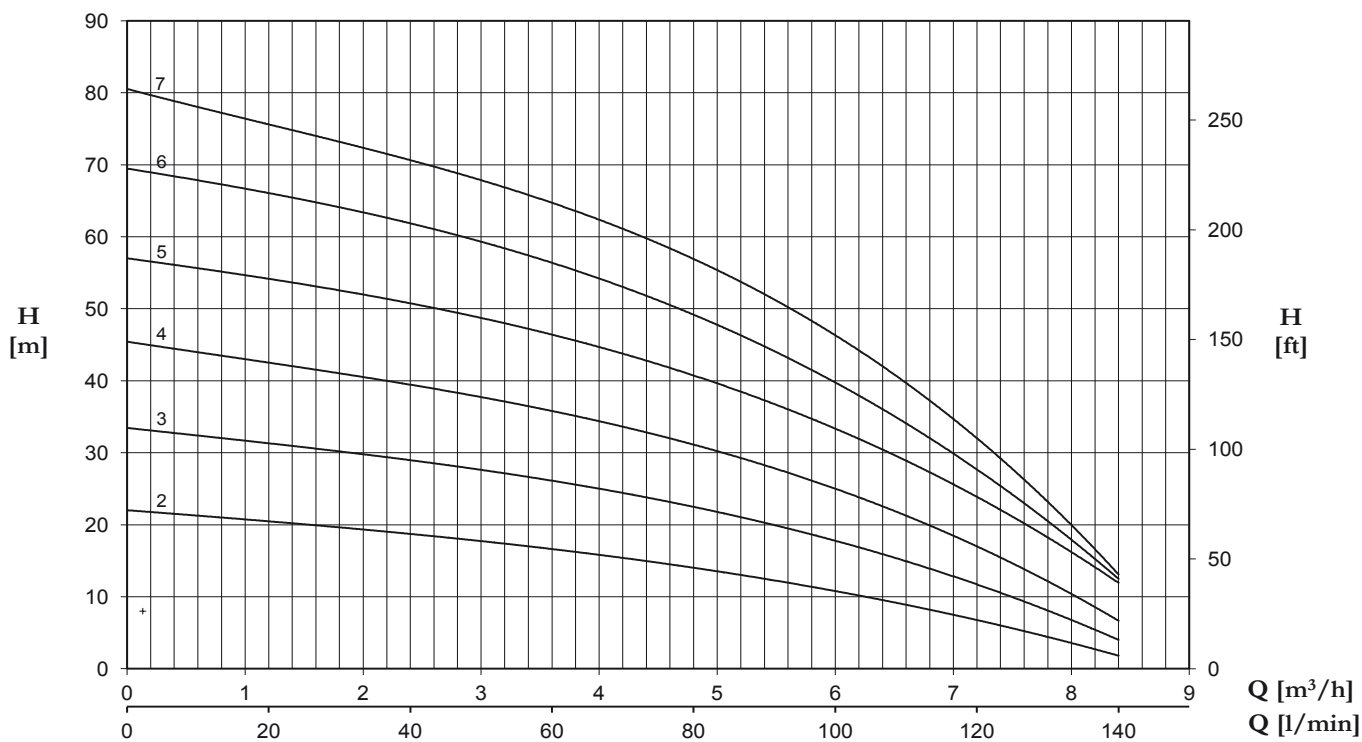

DANE TECHNICZNE PRZY 2900 OBR./MIN. / TECHNICAL PERFORMANCE AT 2900 RPM

Model <i>Model</i>		P2		A		Q (m³/h -l/min)							
1~	3~	HP	kW	1x230V 50Hz	3x400V 50Hz	0	1,8	2,4	3,6	4,8	6	7,2	8,4
						0	30	40	60	80	100	120	140
H (m)													
U 5-70/2	U 5-70/2T	0,7	0,51	2,7	1,1	22	19,7	18,7	16,6	14	10,8	6,8	1,8
U 5-80/3	U 5-80/3T	0,8	0,6	3,9	1,5	33,4	30,3	29	26	22,5	17,6	12	3,9
U 5-120/4	U 5-120/4T	1,2	0,9	5,2	2,5	45,3	41,3	39,6	35,6	30,8	24,9	17,6	6,4
U 5-150/5	U 5-150/5T	1,5	1,1	6,8	2,8	59,8	53	51	46,1	40,1	33,3	24,8	11,5
U 5-180/6	U 5-180/6T	1,8	1,3	7,7	3	69,3	64,4	62	55,6	48,2	39,6	28,8	12
U 5-200/7	U 5-200/7T	2	1,5	9	3,4	80,3	73,6	71	64,5	56,1	46	33,4	12,5

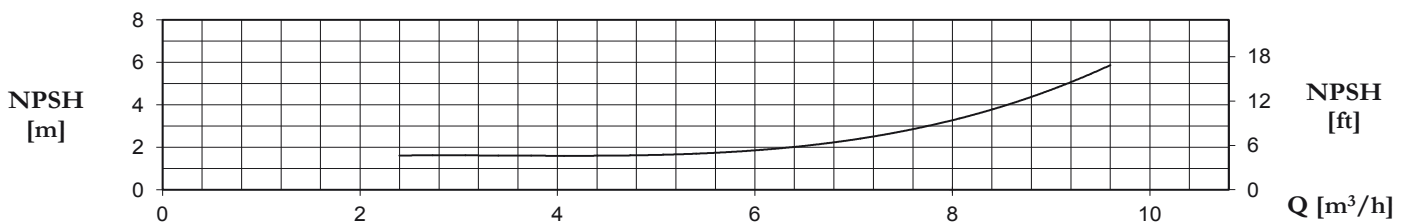
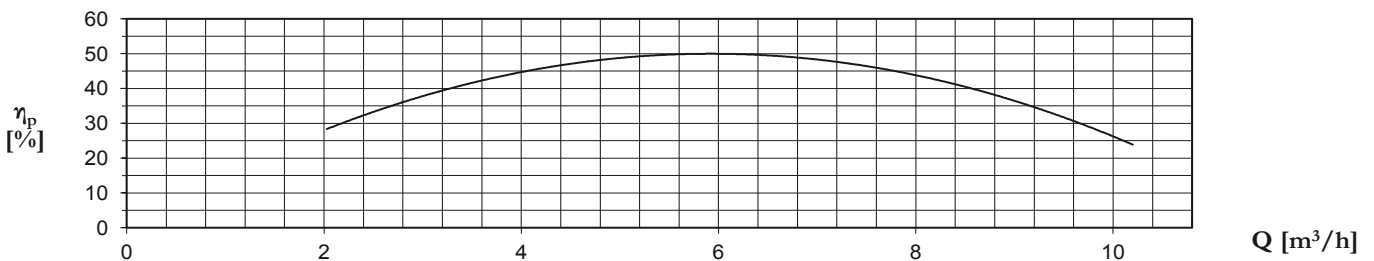
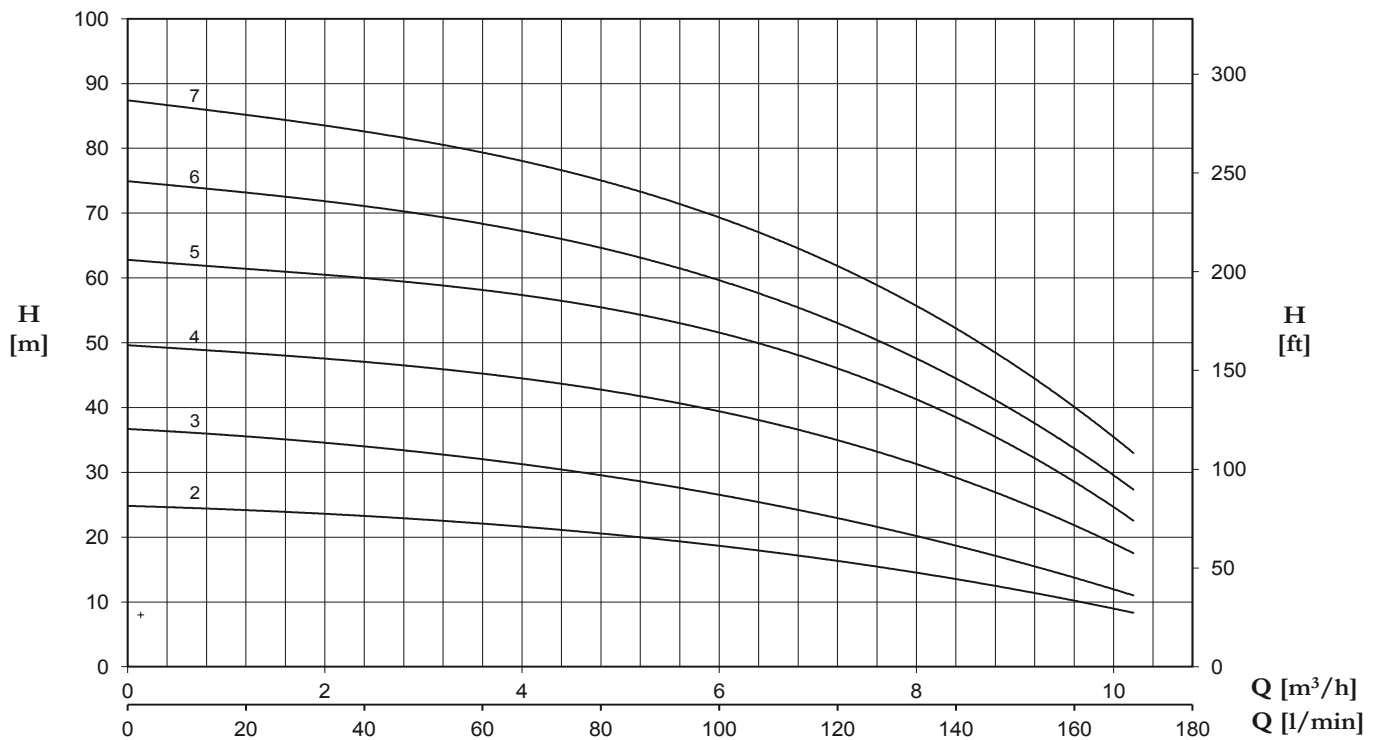

DANE TECHNICZNE PRZY 2900 OBR./MIN. / TECHNICAL PERFORMANCE AT 2900 RPM

Model <i>Model</i>		P2		A		Q (m ³ /h -l/min)									
1~	3~	HP	kW	1x230V 50Hz	3x400V 50Hz	0	2,4	3,6	4,8	6	7,2	8,4	9,6	10,2	
						0	40	60	80	100	120	140	160	170	
H (m)															
U 7-100/2	U 7-100/2T	1	0,75	4,4	1,7	24,8	23,4	22	20,5	18,7	16,3	13,6	10,2	8,3	
U 7-120/3	U 7-120/3T	1,2	0,9	5,9	2,6	36,7	34	32	29,6	26,5	23	18,6	13,8	11	
U 7-180/4	U 7-180/4T	1,8	1,3	8,3	3,2	49,5	47,4	45,3	42,5	39,2	34,8	29,4	22,6	16,9	
U 7-250/5	U 7-250/5T	2,5	1,85	10,9	4,2	62,6	60,6	58,2	55,1	51,1	45,8	39	29,8	21,5	
U 7-300/6	U 7-300/6T	3	2,2	12,2	5	74,8	71,5	68,3	64,5	59,3	53	44,6	34,5	26,7	
-	U 7-350/7T	3,5	2,57	-	5,5	87,2	83,3	79,3	74,6	68,9	61,9	52,5	41	32,2	



ULTRA

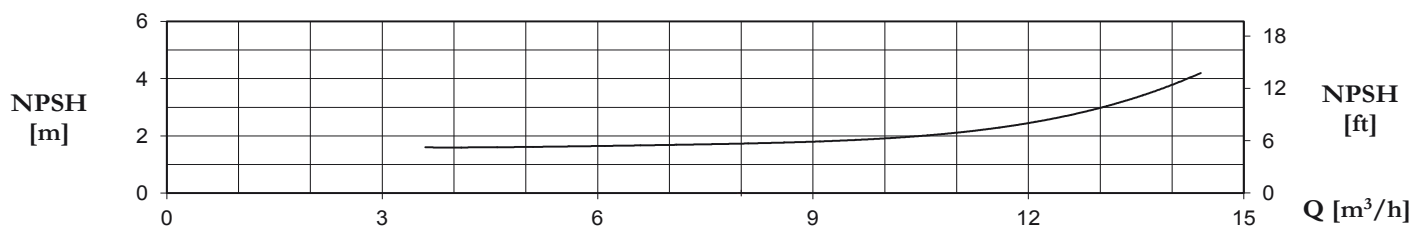
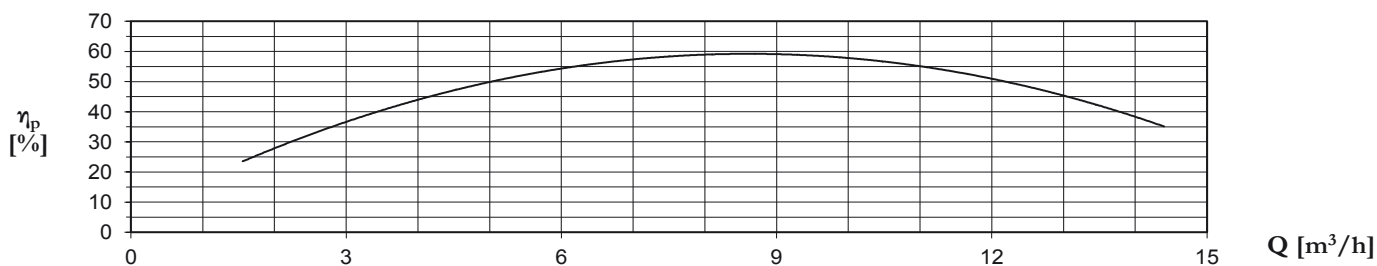
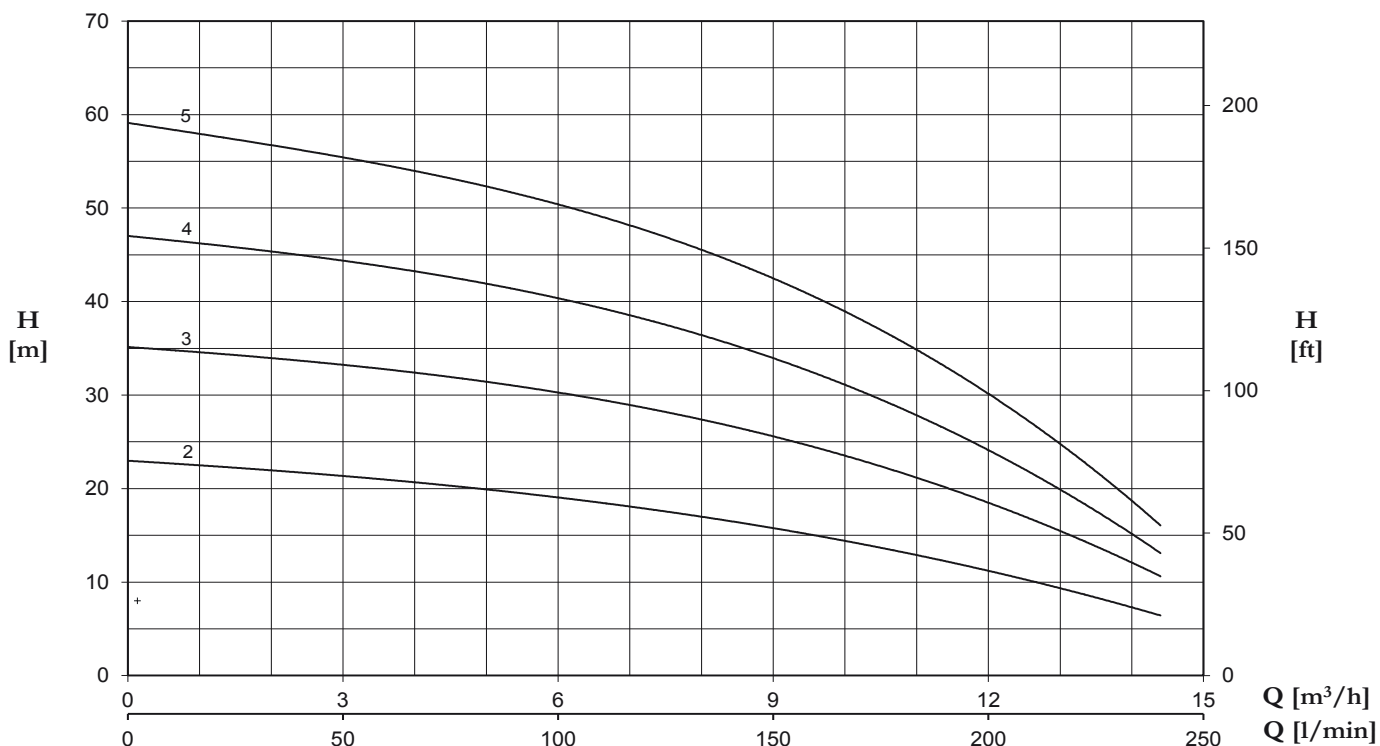

DANE TECHNICZNE PRZY 2900 OBR./MIN. / TECHNICAL PERFORMANCE AT 2900 RPM

Model Model		P2		A		Q (m³/h - l/min)										
						0	3,6	4,8	6	7,2	8,4	9,6	10,8	12	13,2	14,4
1~	3~	HP	kW	1x230V 50Hz	3x400V 50Hz	H (m)										
						0	60	80	100	120	140	160	180	200	220	240
U 9-100/2	U 9-100/2T	1	0,75	4,4	1,7	23	20,9	20	19,1	17,9	16,6	15	13,2	11,1	8,9	6,5
U 9-150/3	U 9-150/3T	1,5	1,1	6,7	2,8	35,2	32,6	31,5	30,3	28,8	26,9	24,5	21,5	18,3	14,7	10,8
U 9-200/4	U 9-200/4T	2	1,5	8,4	3,3	47,1	43,5	42	40,5	38,3	35,7	32,4	28,4	23,8	18,9	13,3
U 9-250/5	U 9-250/5T	2,5	1,85	10,6	4,3	59,2	54,4	52,4	50,4	47,9	44,8	40,5	35,5	29,8	23,5	16,3

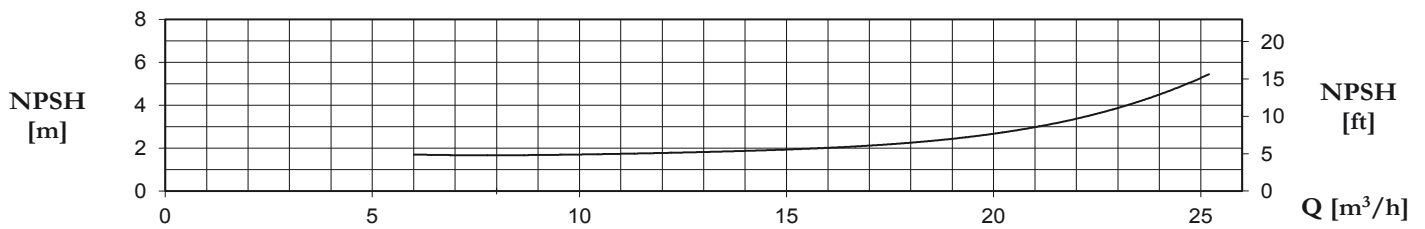
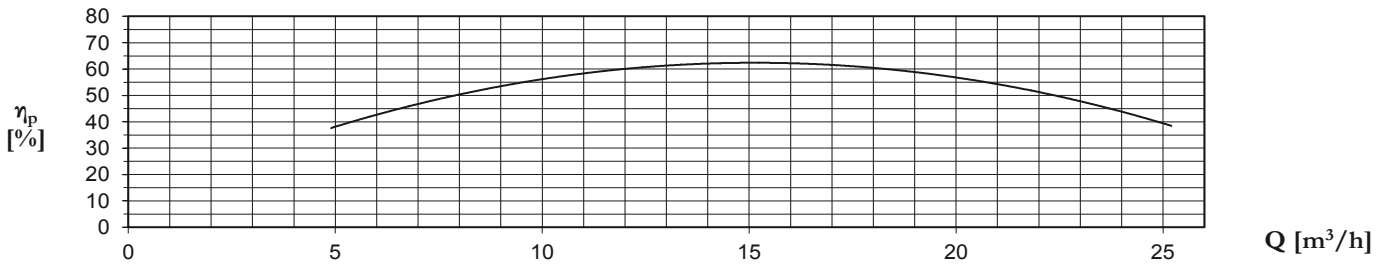
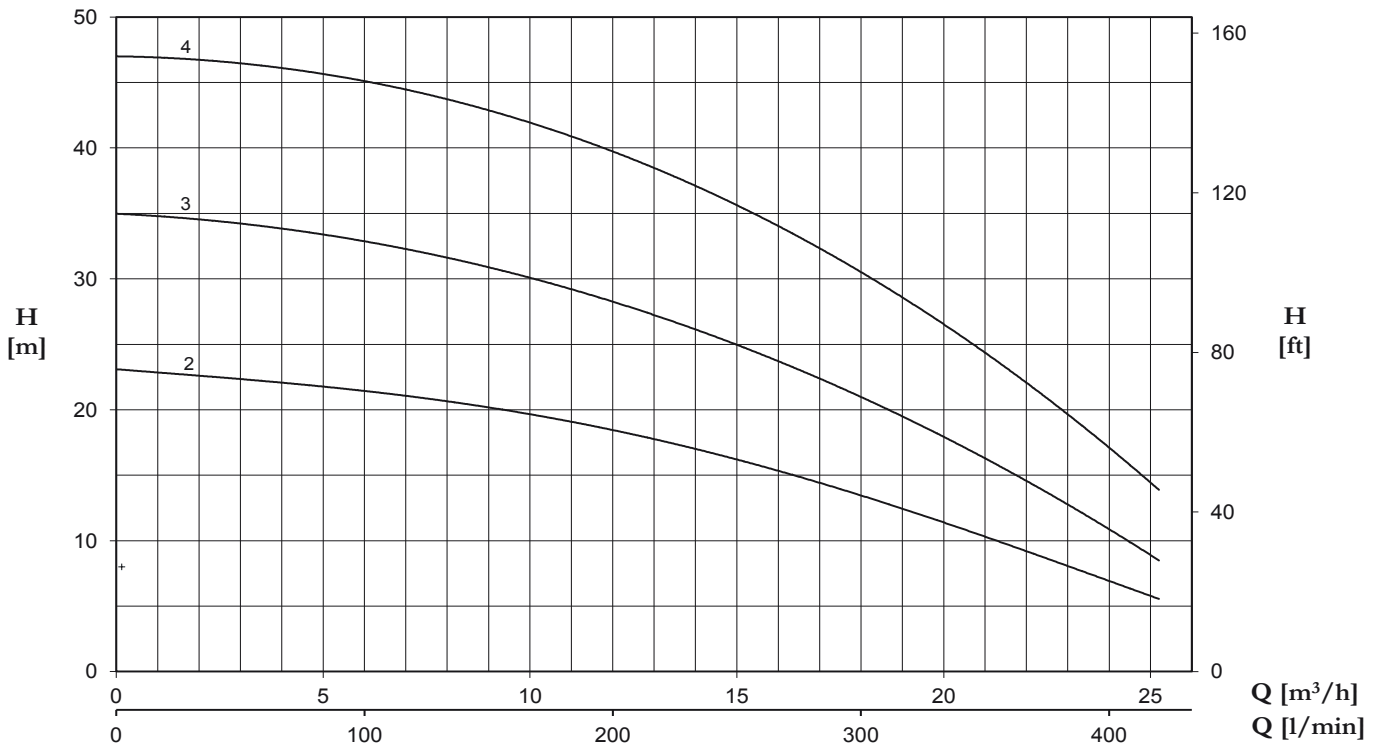

DANE TECHNICZNE PRZY 2900 OBR./MIN. / TECHNICAL PERFORMANCE AT 2900 RPM

Model Model	P2		A	Q (m ³ /h - l/min)																	
	HP	kW		0	6	7,2	8,4	9,6	10,8	12	13,2	14,4	15,6	16,8	18	19,2	20,4	21,6	22,8	24	25,2
3~			3x400V 50Hz	H (m)																	
U 18-180/2T	1,8	1,3	3	23,1	21,4	21	20,5	19,9	19,2	18,4	17,6	16,7	15,7	14,7	13,5	12,1	10,9	9,7	8,3	7	5,5
U 18-250/3T	2,5	1,85	4,3	35	32,7	32,2	31,4	30,5	29,5	28,3	26,7	25,5	24,3	22,8	21,2	19,3	17,3	15,1	12,9	10,8	8,7
U 18-400/4T	4	3	5,5	47,2	44,6	44,1	43,3	42,4	41,2	40	38,5	36,7	34,9	32,9	30,5	27,9	25,3	22,7	20	17,1	14,3

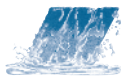

ULTRA

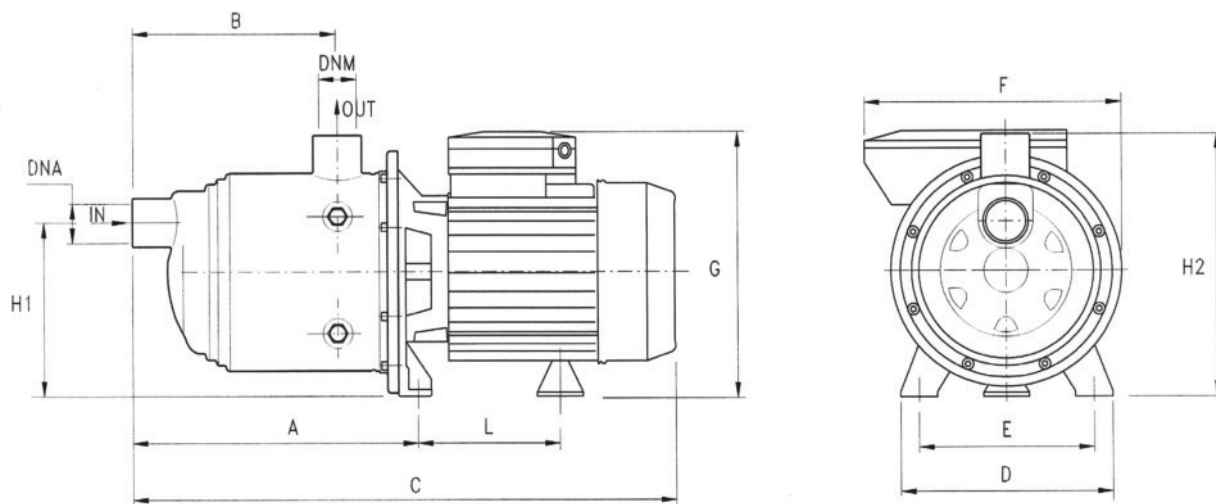

MODEL POMPY PUMP'S MODEL	WYMIARY POMP mm PUMP'S DIMENSIONS										DNA	DNM	WAGA WEIGHT kg
	A	B	C	D	E mm	F	G	L	H1	H2			
U 3-50/2	166,8	103	333	164	140	178	195	93,7	128	192	1" G	1" G	6,3
U 3-70/3	166,8	103	333	164	140	178	195	93,7	128	192			7,2
U 3-90/4	190,8	127	357	164	140	178	195	104,7	128	192			8,3
U 3-100/5	214,8	151	404	164	140	178	203	104,7	128	192			10,6
U 3-120/6	238,8	175	428	164	140	178	203	104,7	128	192			11,0
U 3-150/7	262,8	199	483	164	140	201	211	104,7	128	198			14,1
U 5-70/2	166,8	103	333	164	140	178	195	93,7	128	192			7,1
U 5-80/3	166,8	103	357	164	140	178	203	93,7	128	192			9,5
U 5-120/4	190,8	127	380	164	140	178	203	104,7	128	192			11,1
U 5-150/5	214,8	151	436	164	140	201	211	128,2	134	198			13,5
U 5-180/6	238,8	175	459	164	140	201	211	128,2	134	198			14,4
U 5-200/7	262,8	199	483	164	140	201	211	128,2	134	198			15,2

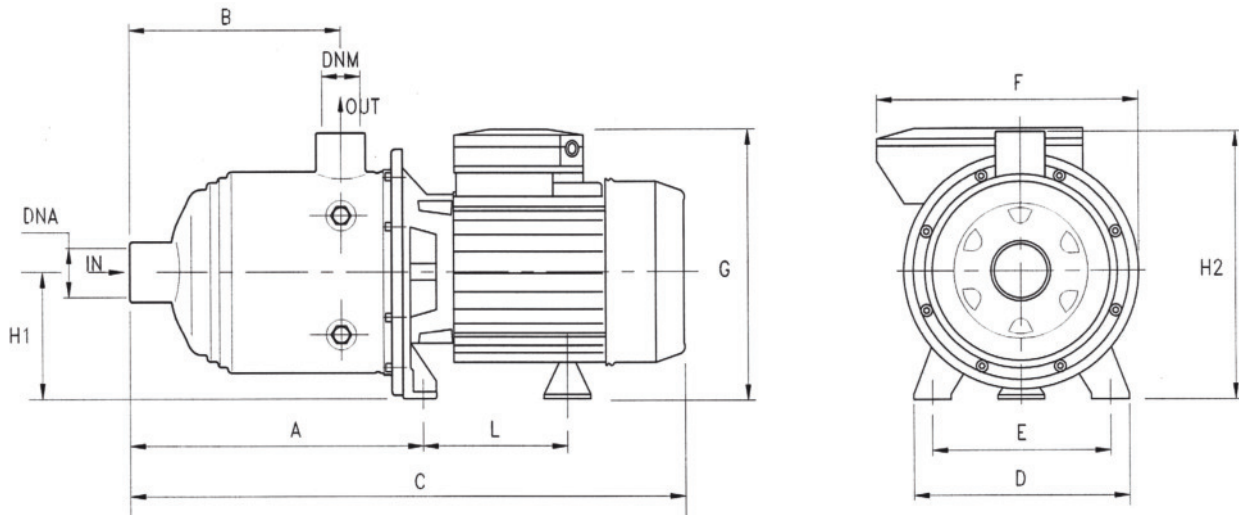

MODEL POMPY PUMP'S MODEL	WYMIARY POMP mm PUMP'S DIMENSIONS										DNA	DNM	WAGA WEIGHT kg
	A	B	C	D	E mm	F	G	L	H1	H2			
U 7-100/2	166,8	103	356	164	140	178	203	93,7	92	192	1"1/4 G	1" G	10,0
U 7-120/3	166,8	103	356	164	140	178	203	93,7	92	192			10,8
U 7-180/4	190,8	127	411	164	140	201	211	128,2	98	198			13,8
U 7-250/5	214,8	151	436	164	140	201	211	128,2	98	198			15,8
U 7-300/6	238,8	175	459	164	140	201	211	128,2	98	198			18,2
U 7-350/7	262,8	199	527	164	140	201	230	148,2	103	203			18,6
U 9-100/2	185,8	122	375	164	140	176	203	104,7	92	192	1"1/2 G	1"1/4 G	10,1
U 9-150/3	185,8	122	375	164	140	201	211	128,2	98	198			13,2
U 9-200/4	216	152	436	164	140	201	211	128,2	98	198			15,5
U 9-250/5	246	182	464	164	140	201	211	128,2	98	198			16,1
U 18-180/2T	201	137	432	164	140	201	211	128,2	98	198	2" G	1"1/2 G	12,9
U 18-250/3T	238,5	174,5	432	164	140	201	211	128,2	98	198			14,5
U 18-400/4T	276	212	514	164	140	201	230	128,2	103	203			20,8